

Direction	1	2	3
Right	○	○	○
Center	○	○	○
Left	○	○	○

Swivel Lever Switch (Right)(Left)			
Swivel Valve	SA	SA	SA
Work Lamp	SA	SA	SA
Hour Meter	SA	SA	SA
Fuel Cut-off	SA	SA	SA
Main Fuel Coil	SA	SA	SA
Swivel Valve	SA	SA	SA
Work Lamp	SA	SA	SA
Hour Meter	SA	SA	SA
Fuel Cut-off	SA	SA	SA
Main Fuel Coil	SA	SA	SA

Fuse Box

Diode	34E	59A
Diode	34C	58A

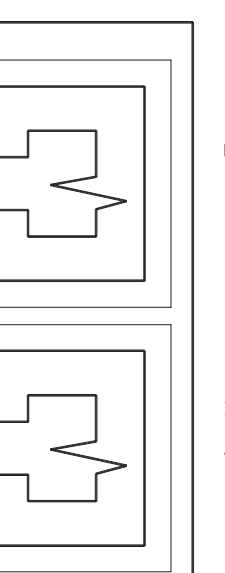

Swivel Limiter Switch

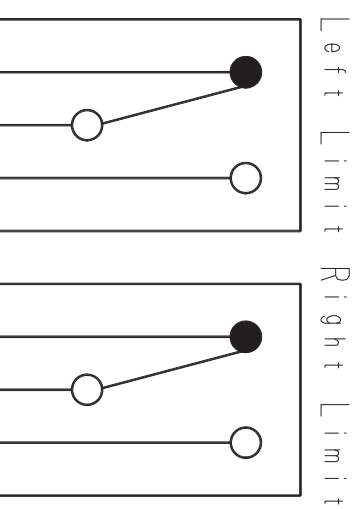

Work Lamp 12V/4W

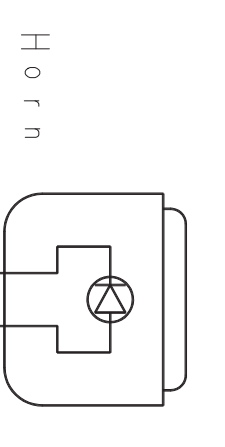

Color Codes	Example: WB
Black-B	White-W
Red-R	Green-G
Yellow-Y	Brown-Br
Blue-L	Orange-Or
Pink-P	Light Green-Lg
Violet-V	Str Blue-Sb

Oil Pressure Switch	
Conditions	
No Pressure	○
Pressured	●

ON	○
OFF	○

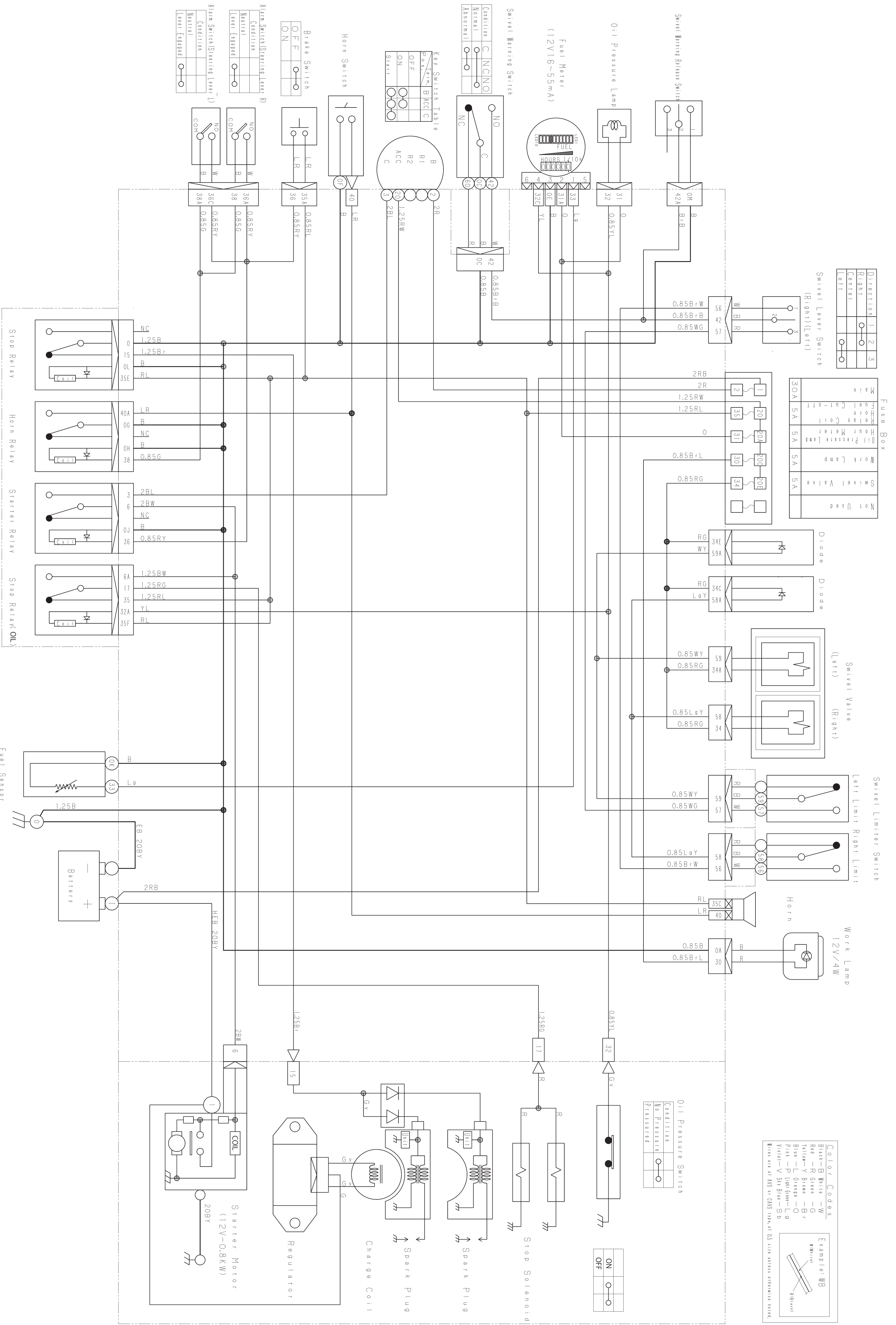
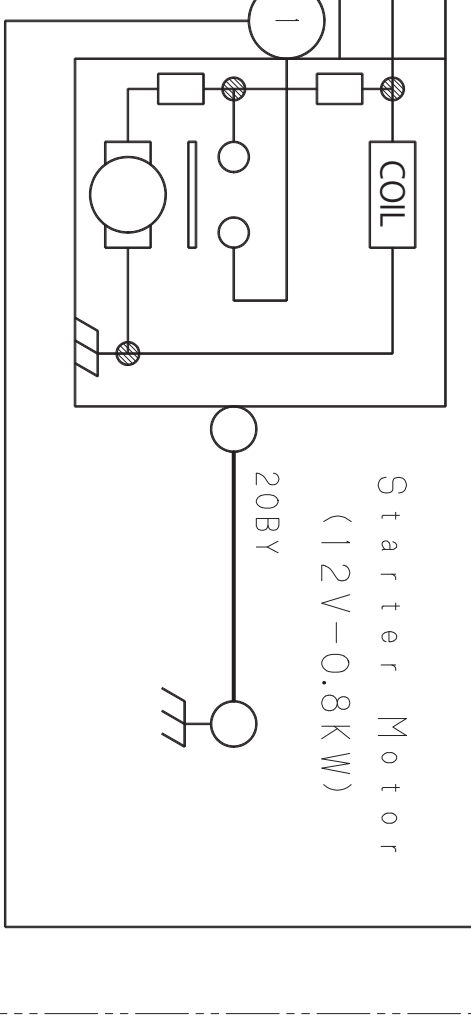
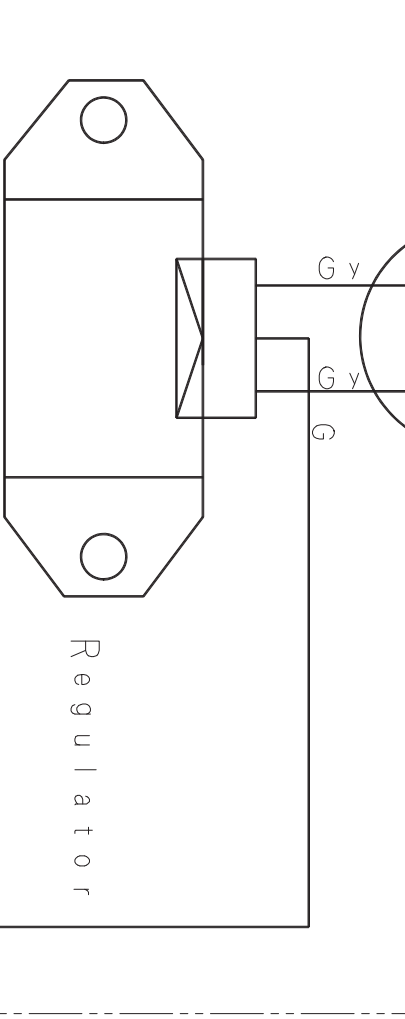
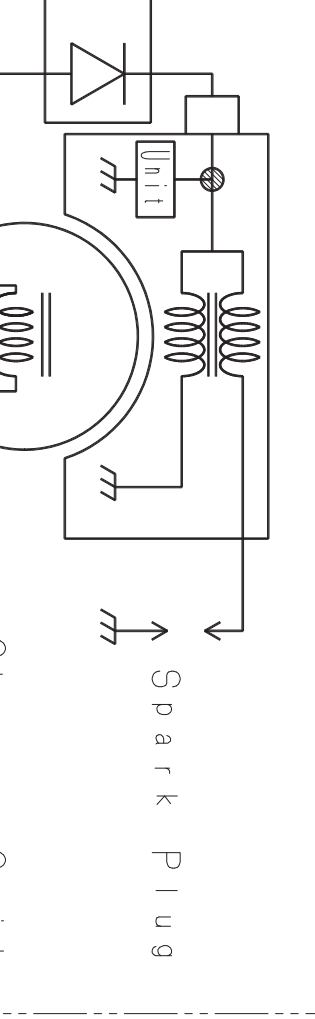
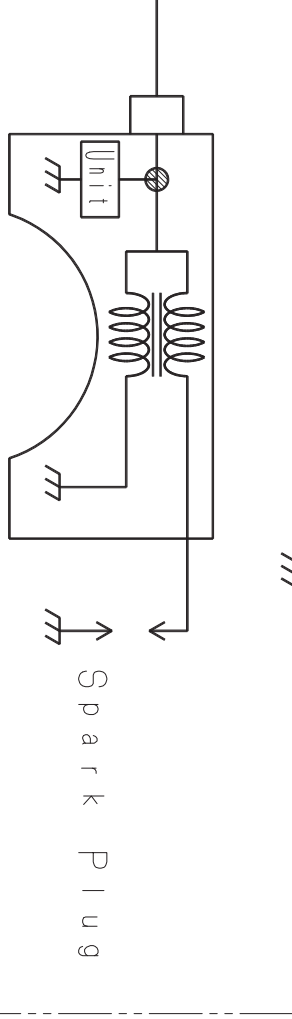
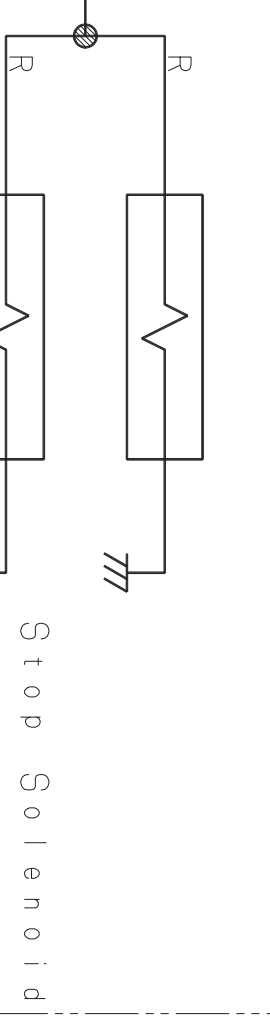

Swivel Warning Switch			
Condition	C	NC	NO
Normal	○	○	○
Abnormal	○	○	○

Key Switch Table			
Pos.	Acc	B	C
OFF	○	○	○
ON	○	○	○
Start	○	○	○

Brake Switch	
OFF	○
ON	○

Alarm Switch (Steering Lever, R)	
Condition	
Neutral	○
Lever Engaged	○

Alarm Switch (Steering Lever, L)	
Condition	
Neutral	○
Lever Engaged	○

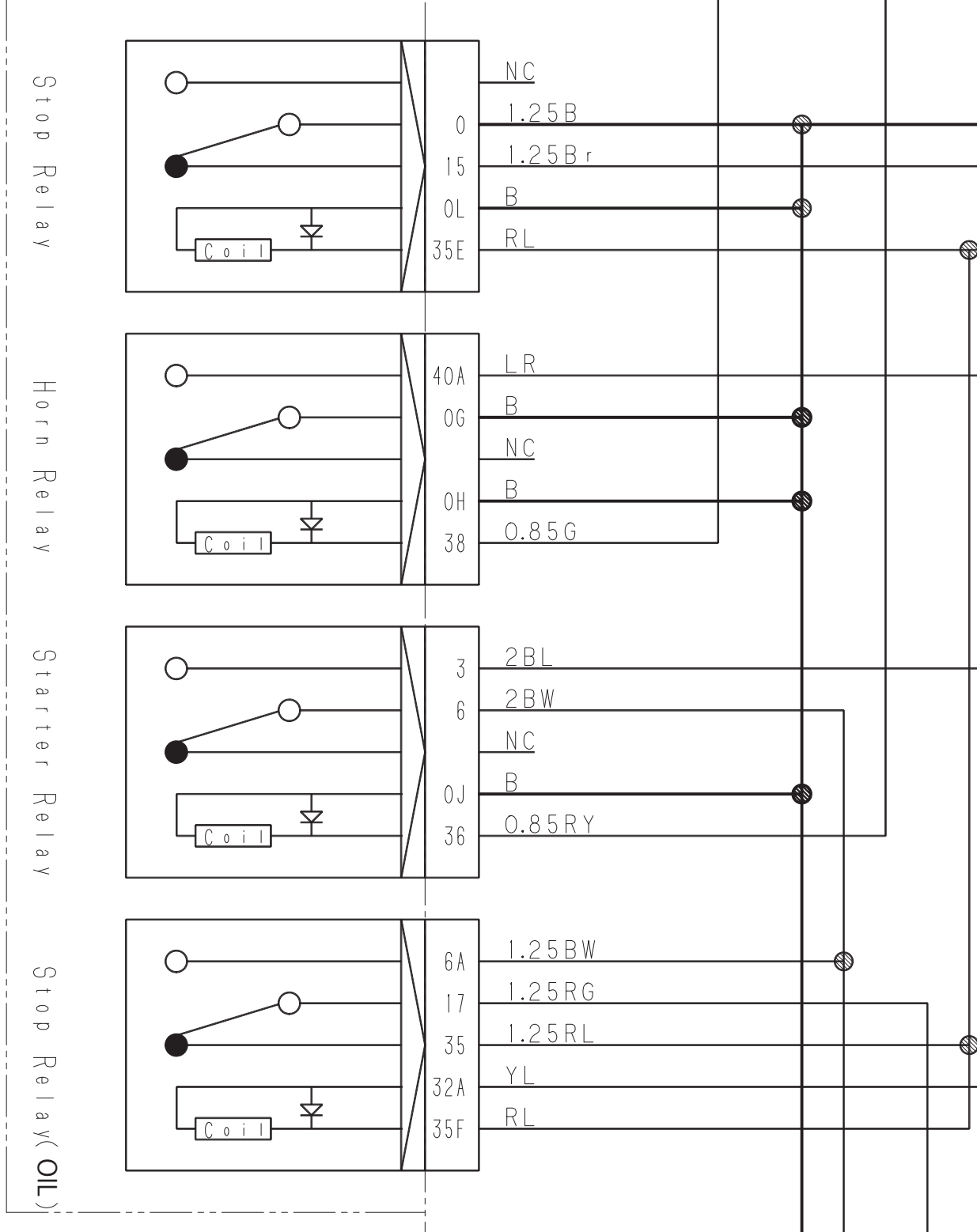

Fuel Sensor



Relay Box